











NOTE:-

- 1- All dimension in millimeter unless otherwise specified.
- 2- The contractor has to submit the coordinated shop drawing with other services before commencing of work and get approval of client.

LEGEND FOR HVAC

S.NO.	SYMBOL	LAYERS NAME
1.		4 WAY CASSETTE
2.		1 WAY CASSETTE
4.		REFNET
5.		REFRIGERANT PIPE (COPPER) WITH 13/19 MM INSULATION
6.		DRAIN PIPE WITH 6 MM INSULATION
7.		ENERGY RECOVERY VENTILATOR (ERV)
8.		SUPPLY AIR DUCT (150MM)
9.		EXHAUST AIR DUCT (150MM)
10.		DISC VALVE
11.		EXHAUST/FRESH AIR LOUVER

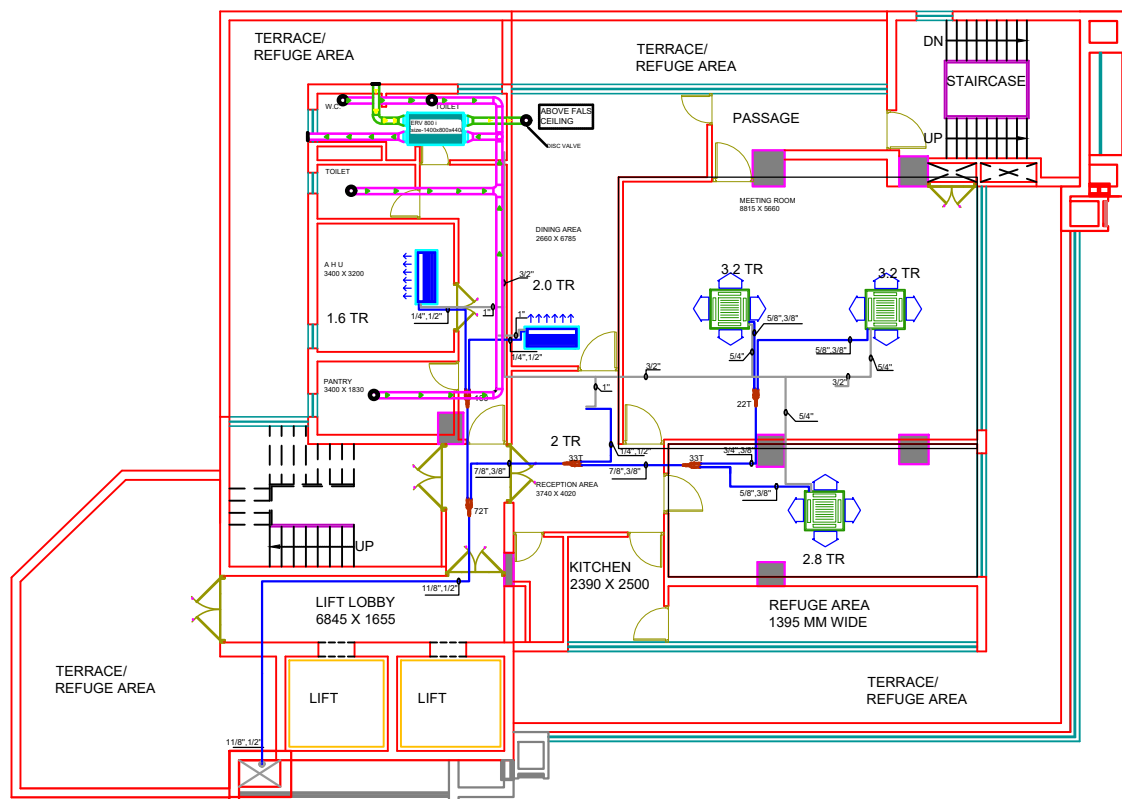

SEVENTH FLOOR PLAN

DRAWN BY :	YASOOB	CHECKED BY :	REHAN	APPROVED BY :	S.M.RAZA	DATE OF ISSUE	16.12.2019
 DUAA Design Consultant D-292/78, HASHIM BUILDING, VICTORIA STREET CHAWK LUCKNOW-226003 Ph. No. : 05224114020, +918009894934 Email : duaadesign@gmail.com,				Document Type-	Document Status-		
				HVAC DRAWING	TENDER		
TITLE :				Rev- 0			
AIR CONDITIONING OF SIDBI TOWER , LUCKNOW							

Project - VRV/ VRF Air Contioning of SIDBI Tower , Lucknow